

Master Grip

MRR-1 / MRW-1 / MLR-1 / MLW-1

USER MANUAL

29th November 2018



Imprint

Copyright © 2018 Arnold & Richter Cine Technik GmbH & Co. Betriebs KG. All rights reserved. No parts of this document may be reproduced without prior written consent of Arnold & Richter Cine Technik GmbH & Co. Betriebs KG. Specifications are subject to change without notice. Errors, omissions, and modifications excepted.

ARRI, ALEXA, AMIRA, Master Grip, LDS and LENS DATA SYSTEM are trademarks or registered trademarks of Arnold & Richter Cine Technik GmbH & Co. Betriebs KG. All other brands or products are trademarks or registered trademarks of their respective holders and should be treated as such. Original version.

For Further Assistance

ARRI Cine + Video Geräte Gesellschaft m.b.H.

Pottendorferstraße 23-25/3/1

A-1120 Vienna Austria

E-mail: service@arri.com

Website: www.arri.com

Scope

This User Manual applies to the following products:

K2.0009493	Master Grip MRR-1 with SUP 2.0.0
K2.0009363	Master Grip MLW-1 with SUP 2.0.0
K2.0009494	Master Grip MRW-1 with SUP 2.0.0
K2.0009490	Master Grip MLR-1 with SUP 2.0.0

Revision history

Version	ID	Order #	Release	Date
01	10001828	K5.0012636	F06114	27.10.2016
02	10001828	K5.0012636	W01235	23.08.2017
03	10001828	K5.0012636	W01449	29.11.2018

Disclaimer

Before using the products described in this manual, be sure to read and understand all the respective instructions.

The ARRI MRR-1 / MRW-1 / MLR-1 / MLW-1 Master Grip is/ are only available to commercial customers. By utilization, the customer agrees that the Master Grip or other components of the system are deployed for commercial use only. Otherwise the customer must contact ARRI before utilization.

While ARRI endeavors to enhance the quality, reliability and safety of their products, customers agree and acknowledge that the possibility of defects thereof cannot be eliminated entirely. To minimize the risk of damage to property or injury (including death) to persons arising from defects in the products, customers must incorporate sufficient safety measures in their work with the system and heed the stated canonic use.

ARRI or its subsidiaries do not assume any responsibility for losses incurred due to improper handling or configuration of the Master Grip or other system components.

ARRI assumes no responsibility for any errors that may appear in this document. The information is subject to change without notice.

For product specification changes after this manual was published, refer to the latest published ARRI data sheets or release notes, etc., for the most up-to-date specifications. Not all products and/or types are available in every country. Please check with an ARRI sales representative for availability and additional information.

Neither ARRI nor its subsidiaries assume any liability for infringement of patents, copyrights or other intellectual property rights of third parties by or arising from the use of ARRI products or any other liability arising from the use of such products. No license, express, implied or otherwise, is granted under any patents, copyrights or other intellectual property right of ARRI or others.

ARRI or its subsidiaries expressly exclude any liability, warranty, demand or other obligation for any claim, representation, cause, action, or whatsoever, express or implied, whether in contract or not, including negligence, or incorporated in terms and conditions, whether by statute, law or otherwise. In no event shall ARRI

or its subsidiaries be liable for or have a remedy for recovery of any special, direct, indirect, incidental, or consequential damages, including, but not limited to lost profits, lost savings, lost revenues or economic loss of any kind or for any claim by a third party, downtime, good-will, damage to or replacement of equipment or property, any cost or recovery of any material or goods associated with the assembly or use of our products, or any other damages or injury of the persons and so on or under any other legal theory.

In the event that one or all of the foregoing clauses are not allowed by applicable law, the fullest extent permissible clauses by applicable law are validated.

Table of Contents

1	For Your Safety	8
2	Audience and Intended Use	10
3	Scope of Delivery and Warranty	11
4	Introduction	12
	4.1 Versions.....	13
	4.2 Sample setups.....	14
	4.3 LBUS.....	19
5	Layout	20
6	Operation	21
7	Menu overview	22
	7.1 Motor screen.....	25
	7.1.1 <i>Speed</i>	25
	7.1.2 <i>Direction</i>	25
	7.1.3 <i>Curve</i>	26
	7.1.4 <i>Motor side</i>	26
	7.1.5 <i>Motor Torque</i>	26
	7.1.6 <i>Axis</i>	26
	7.2 Joystick screen.....	27
	7.3 Button screen.....	28
	7.4 System screen.....	29
8	User buttons	31
9	Assignable functions	32
10	Override Function	34
11	Software update	35
12	Power Disconnection	36
13	Appendix	37
	13.1 Part Numbers.....	37
	13.1.1 <i>Master Grips</i>	37
	13.2 Pinouts.....	48
	13.3 Compatibility.....	48

13.3.1	<i>Software update devices</i>	51
13.4	Specifications.....	52
13.4.1	<i>Dimensions and weight</i>	52
13.5	Service Contacts.....	53
13.6	International declarations.....	54

1 For Your Safety

Before use, please ensure that all users read, understand, and follow the instructions comprehensively in this document.

Risk Levels and Alert Symbols

Safety warnings, safety alert symbols, and signal words in these instructions indicate different risk levels:

DANGER!

DANGER indicates an imminent hazardous situation, which, if not avoided, **will result in** death or serious injury.

WARNING!

WARNING indicates a potentially hazardous situation, which, if not avoided, **may result in** death or serious injury.

CAUTION!

CAUTION indicates a potentially hazardous situation, which, if not avoided, **may result in** minor or moderate injury.

NOTICE

NOTICE explains practices not related to physical injury. No safety alert symbol appears with this signal word.

Note: Provides additional information to clarify or simplify a procedure.

Vital Precautions

DANGER!

Risk of electric shock and fire!

Short-circuits may entail lethal damage!

Before use, read and follow all valid instructions.

Use solely and exclusively as described in the instructions.

Never open. Never insert objects.

For operation, always use a power source as indicated in the instructions.

Always unplug the cable by gripping the plug, not the cable.

Never try to repair. All repair work should be done by a qualified ARRI Service Center.

Never remove or deactivate any safety equipment (incl. warning stickers or paint marked screws).

Always protect from moisture, cold, heat, dirt, vibration, shock, or aggressive substances.

DANGER!

Risk of fire!

Short-circuits and back currents to power supplies/batteries may entail lethal damage!

Always use original ARRI/cmotion LBUS cables to external power sources (D-Tap, XLR)! ARRI/cmotion LBUS cables to external power sources provide a protection circuit to prevent back currents to power supplies/batteries.

2 Audience and Intended Use

NOTICE

The product is solely and exclusively available for commercial costumers and shall be used by skilled personnel only. Every user should be trained according to ARRI guidelines. Use the product only for the purpose described in this document. Always follow the valid instructions and system requirements for all equipment involved.

The Master Grip is solely and exclusively for use on professional camera setups.

3 Scope of Delivery and Warranty

NOTICE

Product and packaging contain recyclable materials. Always store, ship, and dispose of according to local regulations. ARRI is not liable for consequences from inadequate storage, shipment or disposal.

Warranty

For scope of warranty, please ask your local ARRI Service Partner. ARRI is not liable for consequences from inadequate shipment, improper use, or third-party products.

Delivery

On delivery, please check that the package and content are intact. Never accept a damaged or incomplete delivery. A complete delivery includes:

- Master Grip
- User manual
- Original packaging

Note: See "Master Grip sets", page 38 for specific accessories.

4 Introduction



ARRI Master Grips combine effective camera stabilization with flexible and responsive fingertip control of lens and camera while shooting handheld.

Main features

- **Versatile controls:** Full lens control; advanced camera control.
- **Well proven design:** Solid mechanical design; proven ergonomics.
- **Easy to use:** Intuitive user interface; multi-lingual display.
- **Override Function:** Prioritizes Master Grips over wireless control with WCU-4

4.1 Versions

Master Grips are available in four versions: right-side and left-side with either a control rocker or a control wheel. All versions are equipped with a 5-way joystick and a toggle button. Joystick and button are fully customizable and can be assigned to camera functions, as well as Master Grip specific features.

**MASTER GRIP RIGHT ROCKER
MRR-1**

**MASTER GRIP LEFT WHEEL
MLW-1**

**MASTER GRIP RIGHT WHEEL
MRW-1**

**MASTER GRIP LEFT ROCKER
MLR-1**

See "Master Grips", page 37 for further information on the different versions.

4.2 Sample setups

ALEXA Mini / Cine lens

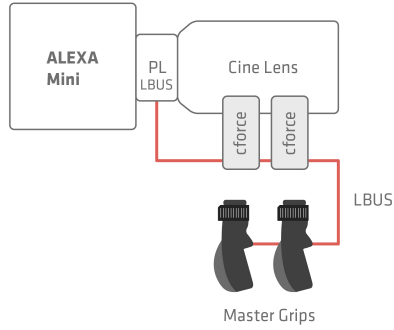

ALEXA Mini / Cine lens / Wireless

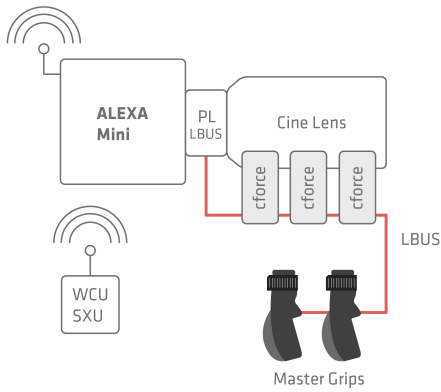

ALEXA Mini / EF lens

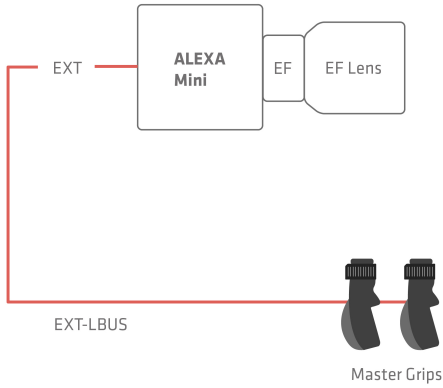

ALEXA Mini / Servo zoom lens

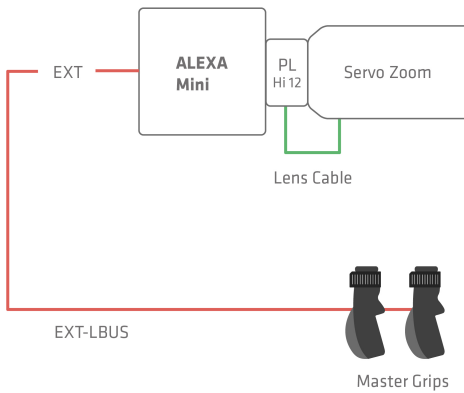

ALEXA Plus / Cine lens / Wireless

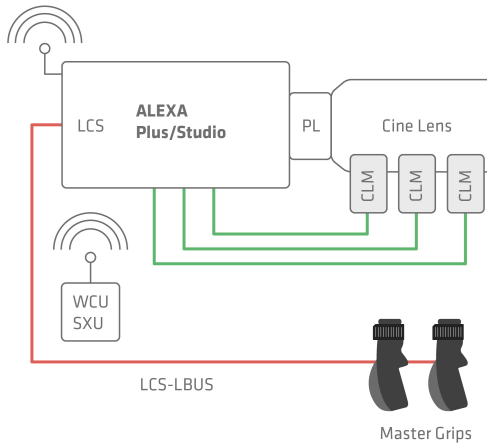

AMIRA / Cine lens

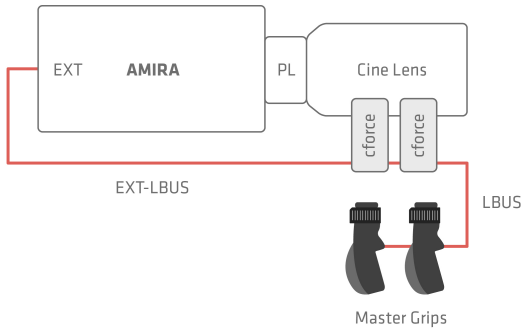

AMIRA / EF lens

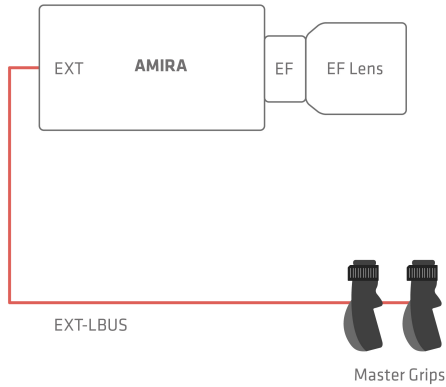

AMIRA / Multicam / Cine lens

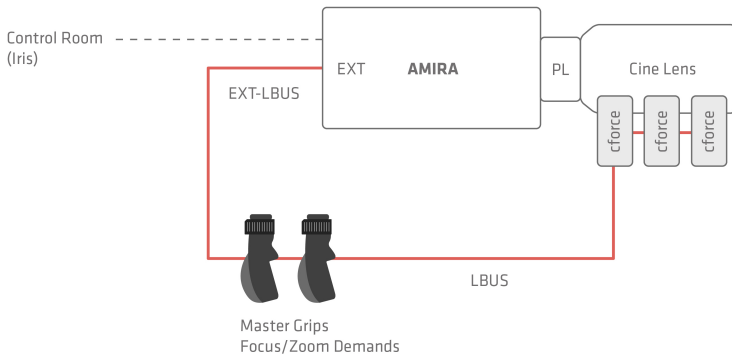

AMIRA / Servo zoom lens

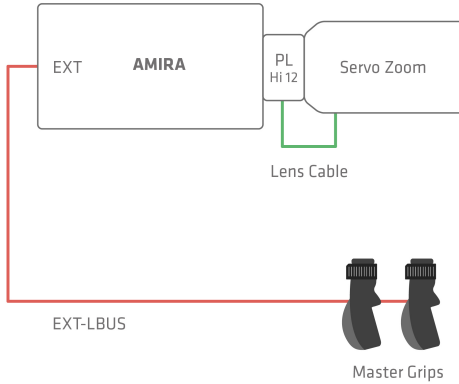

Third party camera / Servo zoom lens

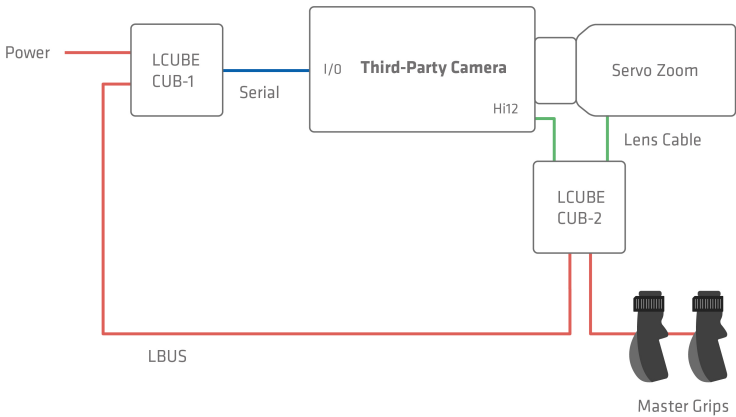

Note: See "Compatibility", page 48 for information about required software versions.

4.3 LBUS

LBUS is an ARRI/cmotion bus standard designed to allow multiple lens motors and control devices to communicate with each other.



5 Layout



- 1 LBUS connectors
- 2 ARRI steel rosette with angle-adjustment
- 3 Customizable 5-way joystick
- 4 Customizable button
- 5 Touch screen
- 6 Control wheel
- 7 Control rocker

6 Operation

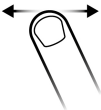
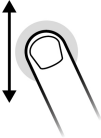
The main user interface of the Master Grips is the touchscreen. Use the touch gestures below for navigating through the menus. It is also possible to use the joystick for navigation. This feature is disabled by default and needs to be enabled in the SYSTEM menu (See "System screen", page 29).

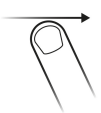
Input:		Action:
Gesture: Swipe left/ right		Top-level screen: Navigate between the top level screens
Gesture: Swipe up/down		Top-level screen: Perform or skip the motor calibration (if displayed). Menu: Scroll up and down.
Joystick: Push up/down		
Gesture: Long touch	1 sec 	Top-level screen: Enter setup menu.
Gesture: Short tap	Tap 	Top-level screen: Display information about the tapped-on element (if available). Menu: Select a menu item
Joystick: Push center / right		
Gesture: Swipe right		Menu: Navigate one menu-level up.
Joystick: Push left		

7 Menu overview

Top-level menus

The Master Grip has 4 different top-level screens. To navigate between them, swipe left/right.

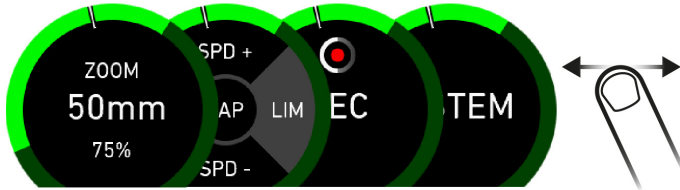

- "Motor screen", page 25
- "Joystick screen", page 27
- "Button screen", page 28
- "System screen", page 29

Indicator Gauge

The indicator gauge is displayed on all top-level screens. It indicates the motor position, the motor limits set by the user and the camera status. For setting user defined limits, assign the LIM function to one of the joystick directions or the button (See "Joystick screen", page 27 or "Button screen", page 28).

Gauge limits:

- 1 Lower motor calibration limit
- 2 Upper motor calibration limit
- 3 Lower limit
- 4 Upper limit
- 5 Current motor position

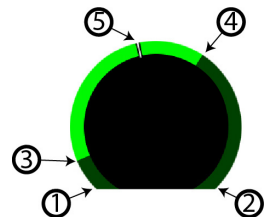

Gauge colors:

- 1 Blue: No camera
- 2 Grey: Camera not ready to record (insert media)
- 3 Green: Standby - ready to record
- 4 Orange: Pre-Recording
- 5 Red: Recording

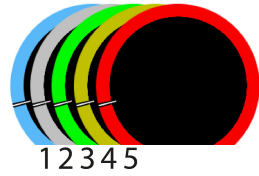

Setup menus:

Every top-level screen has its own setup menu. To enter the setup menu, perform a long touch on the top-level screen or, in case of the joystick screen, on one of its segments.

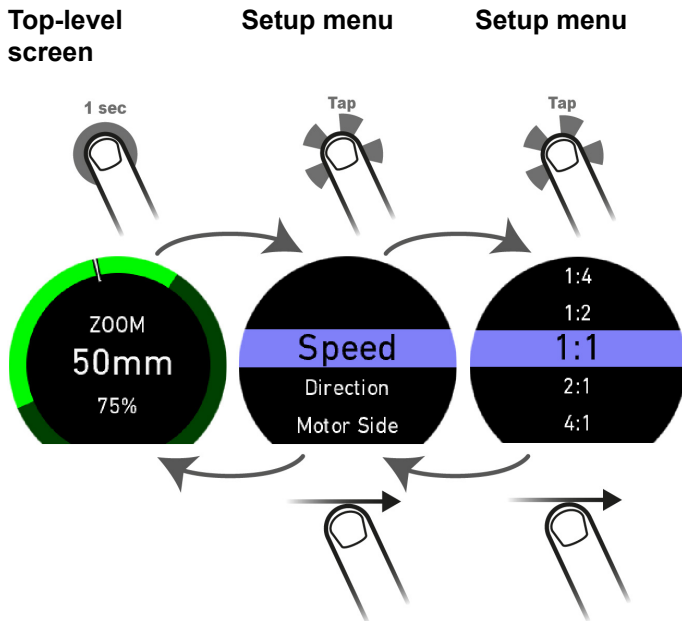

To navigate the sub-menus scroll up or down and tap for selection. To navigate one menu level up, swipe right. If multi-mode menu control (See "System screen", page 29) is

enabled, press the joystick up/down for scrolling up/down and press joystick center or right to select a menu item. Press joystick left to navigate one menu level up.

Joystick and button mapping

The joystick and button top-level screens reflect the physical layout of a Master Grip:



7.1 Motor screen

The motor screen is the default start-up screen.

Example 1:

Master Grip Rocker is assigned to zoom axis, speed set to 75%. Motor limits are set.

Camera is in standby mode.

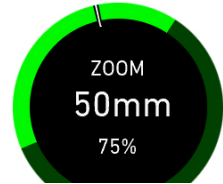

Example 2:

Master Grip Wheel is assigned to iris axis, ratio is set 1:4. Motor limits are set. Camera is recoding.

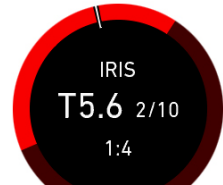

Calibration

If a new motor is connected or the motor axis has been changed, a motor calibration is necessary. The Master Grip will display a calibration request on the motor screen. Swipe up to calibrate the motor. If the calibration request is skippable, swipe down to skip.



7.1.1 Speed

Set the motor speed from minimum to maximum. If the Master Grip has a control wheel, the speed is set as the ratio between lens range and wheel range (1:4, 1:2, 1:1, 2:1, 4:1), if it has a control rocker, then the speed is indicated in percentage (1-100%).

7.1.2 Direction

This option sets the operation direction of the input device (control rocker/control wheel).

7.1.3 Curve

The acceleration behavior of the control rocker and wheel can be set to following curves:
LIN, EXP1, EXP2, EXP3

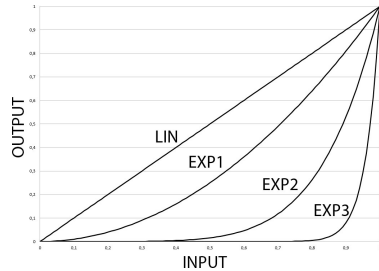

NOTICE

When using the wheel, the curve only affects the acceleration behavior and responsiveness of the wheel movement.

7.1.4 Motor side

The motor side is referring to mounting the motor to rods below the lens. If you mount the rods above the lens, select the opposite side in the setup menu.

7.1.5 Motor Torque

Set the motor torque level from 1 (lowest) to 4 (highest).

NOTICE

Ensure that the motor torque level matches the lens to avoid lens damage. Stiff, hard-to-move lenses require a higher torque level.

7.1.6 Axis

Allows you to select the main axis which is controlled by the Master Grip: focus, iris or zoom.

Note: The focus/iris toggle function (See "Joystick screen", page 27 or "Button screen", page 28) requires at least one of both axes set as main axis.

7.2 Joystick screen

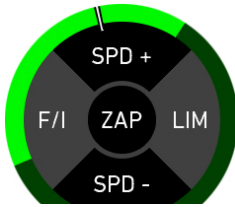

Fig. 1: Joystick top-level screen

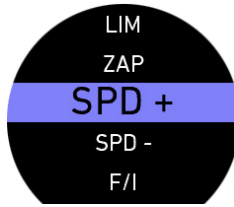

Fig. 2: Joystick setup menu

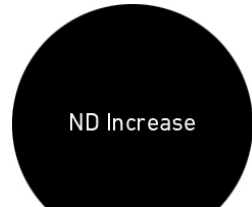

Fig. 3: Function info screen

The five joystick positions can be assigned to several functions (See "Assignable functions", page 32 for all available options).

To assign a function, perform a long touch on one of the five segments of the joystick top-level screen (Fig. 1). Scroll up/down to highlight the function. Perform a short tap to select the highlighted function (Fig. 2).

If a camera user button is assigned, perform a short tap on one of the segments in the main screen and the respectively assigned camera user button function will be displayed (Fig. 3).

7.3 Button screen



Fig 4: Button top-level screen



Fig. 5: Button setup menu

The red button can be assigned to several functions (See "Assignable functions", page 32 for available options).

To assign a function, perform a long touch on the button top-level screen (Fig. 4). Scroll up/down to highlight the function. Perform a short tap to select the highlighted function (Fig. 5).

If a camera user button is assigned, perform a short tap in the main screen and the respectively assigned user button function will be displayed.

7.4 System screen

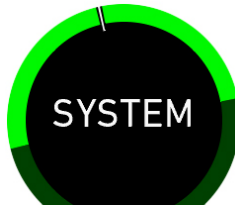

Fig 6: System top-level screen



Fig. 7: System setup menu

The System top-level screen provides access to system-related settings. To enter the system setup menu, perform a long touch on the System top-level screen (Fig. 6). Scroll up/down to highlight the function. Perform a short tap to select the highlighted function (Fig. 7).

Language	Set the system language. Available languages are English, Spanish, Chinese, German
Flip Display	Flips the display
Display *	Set the display illumination from 1 (lowest) to 5 (brightest)
OVR Mode	Set Override mode: override works always (ALWAYS) or only in Stand-by mode (STBY ONLY)
REC Indicator	Activate/Deactivate the gauge indicating the camera recording status.
Menu Control	Control the menu via touch screen (TOUCH ONLY) or touch screen and joystick (MULTI).
Disp. Timeout	Set timeout of the display illumination. Options are: NEVER (=always on), 3 SEC, 10 SEC, 30 SEC

Status	Displays the serial number of the control device and the the installed software update package.
Presets	Save and load up to 5 user presets. For a factory reset, select "Load" and then "Reset".

8 User buttons

It is possible to control up to 6 camera user buttons per Master Grip. The corresponding function of a user button has to be set on the camera. Please check the designated camera user manual on how to set the user buttons. See "Cameras and lenses", page 48 for compatible cameras.

9 Assignable functions

The following functions can be assigned to the joystick (**J**) or the button (**B**).

REC	B	Start/stop recording.
LIM	B/J	<p>Set and reset motor limits as follows:</p> <ol style="list-style-type: none"> 1 Move the motor to the first limit position. 2 Press the joystick/button the LIM function is assigned to. The first limit is set. 3 Move the motor to second limit. 4 Press the button again. The second limit is set. The motor now only operates in the defined range between both limits. 5 For resetting the limits, press LIM again. <p>Note: LIM function not supported when OVR is activated.</p>
MAX SPD	B/J	Press and hold the joystick/button assigned to MAX SPD to operate the lens motor at maximum speed (100% for rocker, 4:1 for wheel).
SPD+	J	Increase speed.
SPD-	J	Decrease speed.
OVR	B/J	Focus, iris, zoom override function: prioritizes Master Grip control over wireless control (WCU-4)
FIZ	B/J	Toggle between controlling focus, iris or zoom. To use this function, the motor axis has to be set to either focus, iris or zoom.
F/I	B/J	Toggle between controlling focus or iris. To use this function, the motor axis has to be set to either focus or iris.
SET TO F	B/J	Controlling focus

SET TO I	B/J	Controlling iris
SET TO Z	B/J	Controlling zoom
UB1..12	B/J	Activate/deactivate camera user button functions. See "User buttons", page 31.
CTRL LCK	B/J	Locks the rocker or wheel. A locked control element is indicated by a red colored lock icon indicator. Using a locked wheel or rocker, a short info "Control is Locked" pops up. A factory reset unlocks the controls.
TCH LCK	B/J	Locks the touchscreen. A locked touchscreen is indicated by short info "Touch Lock".
FOC TRK	B/J	Activate/deactivate focus tracking functions. Motor remains on the tracked focus distance after button release.
JOY. LCK	B	Locks the joystick. A locked joystick is indicated by a padlock symbol on the motor screen.
OFF	B/J	No function is mapped to this button.

10 Override Function

The override function (OVR) enables operators to override and return focus, iris and zoom controls of the WCU-4 hand unit:

Workflow

STEP 1

Assign the User Buttons with the function of your choice: FIZ, F/I, SET TO F, SET TO I or/and SET TO Z.

STEP 2

Select the lens axis (focus, iris, zoom) which shall be taken from the WCU-4.

As the WCU-4 still has control over that axis, the Master Grip shows the indication "No Control" for FOCUS or IRIS or ZOOM.

STEP 3

Press the OVR button to gain control over the selected lens axis.

The WCU-4 hand unit cannot control axis overtaken by the Master Grip anymore (see WCU-4 manual for further details on the override behavior of the WCU-4).

STEP 4

To return axis control to the WCU-4 press the assigned OVR button on the Master Grip again.

Override Indications

- OVR appears on display (Fig. 8)
- Lens data appears on display (Fig. 8)

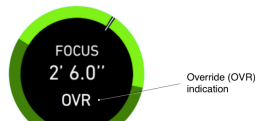

Fig. 8: Motor screen

11 Software update

Always update the Master Grip with the latest firmware. The latest firmware and release notes can be downloaded at www.arri.com/ecs/mastergrips.

The following devices are capable of updating the Master Grip firmware:

- UMC-4
- AMC-1
- WCU-4

See "Software update devices", page 51 for the dedicated software versions.

Please check on the respective user manual how to perform an LBUS device firmware update.

WARNING!

Do not switch off power during the update as this may damage the Master Grip.

12 Power Disconnection

⚠ CAUTION!

To disconnect the device safely from the power source, pull both plugs. Mount and operate the device in an orientation that guarantees easily accessible plugs.

13 Appendix

13.1 Part Numbers

13.1.1 Master Grips

K2.0009493 Master Grip Right Rocker MRR-1
Solid, ergonomic right-side camera hand-grip with assignable user buttons and a control rocker for super-smooth zooming. Includes a steel ARRI rosette and two LBUS interfaces.



K2.0009490 Master Grip Left Rocker MLR-1
Solid, ergonomic left-side camera hand-grip with assignable user buttons and a control rocker for super-smooth zooming. Includes a steel ARRI rosette and two LBUS interfaces.



K2.0009494 Master Grip Right Wheel MRW-1
Solid, ergonomic right-side camera hand-grip with assignable user buttons and a finger wheel for iris or focus adjustments. Includes a steel ARRI rosette and two LBUS interfaces.



K2.0009363 Master Grip Left Wheel MLW-1
Solid, ergonomic left-side camera hand-grip with assignable user buttons and a finger wheel for iris or focus adjustments. Includes a steel ARRI rosette and two LBUS interfaces.



Master Grip sets

The Master Grips are available in following sets.

Note: cforce motors, respective LBUS cables, ENG lens cable and rods/supporting hardware are not included! We recommend using angled LBUS connectors on Master Grips when connecting to cforce motors or other devices (e.g. K2.0013043 Cable LBUS (angled) to LBUS (straight) 80 cm).

KK.0013205 (equals K0.0013088)	Master Grip Zoom Set for AMIRA
contains	
K2.0009493	Master Grip Right Rocker MRR-1
K2.0009363	Master Grip Left Wheel MLW-1
K2.0012911	Handgrip Extension 160 mm
K2.0012921	Cable Clip 15 mm
K2.47136.0	Extension Tube for Handgrip
K2.0013007	Rod Mounting Bracket RMB-4
K2.66255.0	15 mm Reduction Insert
K2.0012628	Cable AMIRA EXT (straight) to LBUS (angled) 80 cm
K2.0013040	Cable LBUS (angled) to LBUS (angled) 60 cm
K2.0012965	Master Grip Case

KK.0013208 (equals K0.0013095)	Master Grip Prime Set for AMIRA
contains	
K2.0009494	Master Grip Right Wheel MRW-1
K2.0009363	Master Grip Left Wheel MLW-1
K2.0012911	Handgrip Extension 160 mm
K2.0012921	Cable Clip 15 mm
K2.47136.0	Extension Tube for Handgrip
K2.0013007	Rod Mounting Bracket RMB-4
K2.66255.0	15 mm Reduction Insert
K2.0012628	Cable AMIRA EXT (straight) to LBUS (angled) 80 cm
K2.0013040	Cable LBUS (angled) to LBUS (angled) 60 cm
K2.0012965	Master Grip Case

KK.0013210 (equals K0.0013089)	Master Grip Zoom Set for ALEXA Mini
contains	
K2.0009493	Master Grip Right Rocker MRR-1
K2.0009363	Master Grip Left Wheel MLW-1
K2.0012911	Handgrip Extension 160 mm
K2.0012921	Cable Clip 15 mm
K2.47136.0	Extension Tube for Handgrip
K2.0013042	Cable LBUS (angled) to LBUS (straight) 35 cm
K2.0013040	Cable LBUS (angled) to LBUS (angled) 60 cm
K2.0012965	Master Grip Case

KK.0013211 (equals K0.0013093)	Master Grip Prime Set for ALEXA Mini
contains	
K2.0009494	Master Grip Right Wheel MRW-1
K2.0009363	Master Grip Left Wheel MLW-1
K2.0012911	Handgrip Extension 160 mm
K2.0012921	Cable Clip 15 mm
K2.47136.0	Extension Tube for Handgrip
K2.0013042	Cable LBUS (angled) to LBUS (straight) 35 cm
K2.0013040	Cable LBUS (angled) to LBUS (angled) 60 cm
K2.0012965	Master Grip Case

KK.0013213 (equals K0.0013094)	Master Grip Zoom Set for ALEXA Plus/Studio
contains	
K2.0009493	Master Grip Right Rocker MRR-1
K2.0009363	Master Grip Left Wheel MLW-1
K2.0012911	Handgrip Extension 160 mm
K2.0012921	Cable Clip 15 mm
K2.47136.0	Extension Tube for Handgrip
K2.0013044	Cable LBUS (angled) to LCS 80 cm
K2.0013040	Cable LBUS (angled) to LBUS (angled) 60 cm
K2.0012965	Master Grip Case

KK.0013214 (equals K0.0013090)	Master Grip Prime Set for ALEXA Plus/Studio
contains	
K2.0009494	Master Grip Right Wheel MRW-1
K2.0009363	Master Grip Left Wheel MLW-1
K2.0012911	Handgrip Extension 160 mm
K2.0012921	Cable Clip 15 mm
K2.47136.0	Extension Tube for Handgrip
K2.0013044	Cable LBUS (angled) to LCS 80 cm
K2.0013040	Cable LBUS (angled) to LBUS (angled) 60 cm
K2.0012965	Master Grip Case

KK.0013215 (equals K0.0013092)	Master Grip Zoom Set for 3rd Party Cameras
contains	
K2.0009493	Master Grip Right Rocker MRR-1
K2.0009363	Master Grip Left Wheel MLW-1
K2.0012911	Handgrip Extension 160 mm
K2.0012921	Cable Clip 15 mm
K2.47136.0	Extension Tube for Handgrip
K2.0008630	LCUBE CUB-1
K2.0010681	LCUBE CUB-2
K2.0009620	LCUBE Bracket
K2.0013040	Cable LBUS (angled) to LBUS (angled) 60 cm
K2.0012631	Cable CUB-1 to F5/55 cameras 80 cm
K2.0012632	Cable CUB-1 to RED cameras 40 cm
K2.0012633	Cable CUB-1 to LANC 40 cm
K2.0013194	Cable CUB-2 to camera Hi12 50 cm
K2.0012965	Master Grip Case

KK.0013216 (equals K0.0013091)	Master Grip Prime Set for 3rd Party Cameras
contains	
K2.0009494	Master Grip Right Wheel MRW-1
K2.0009363	Master Grip Left Wheel MLW-1
K2.0012911	Handgrip Extension 160 mm
K2.0012921	Cable Clip 15 mm
K2.47136.0	Extension Tube for Handgrip
K2.0008630	LCUBE CUB-1
K2.0009620	LCUBE Bracket
K2.0013040	Cable LBUS (angled) to LBUS (angled) 60 cm
K2.0012631	Cable CUB-1 to F5/55 cameras 80 cm
K2.0012632	Cable CUB-1 to RED cameras 40 cm
K2.0012633	Cable CUB-1 to LANC 40 cm
K2.0012965	Master Grip Case

LBUS cables

K2.0006749	Cable LBUS 0,2 m/8" LCB-3
K2.0006750	Cable LBUS 0,3 m/1 ft LCB-4
K2.0006751	Cable LBUS 0,5 m/1.6 ft LCB-A
K2.0006752	Cable LBUS 0,8 m/2.6 ft LCB-1
K2.0006753	Cable LBUS 1,5 m/5 ft LCB-5
K2.0006754	Cable LBUS 3 m/10 ft LCB-1-01
K2.0006755	Cable LBUS 6 m/20 ft LCB-2
K2.0006756	Cable LBUS 15 m/49 ft LCB-1-15
K2.0007318	Cable LBUS to LCS 0,8 m/2.6 ft
K2.0006757	Cable LBUS to D-Tap 1,2 m/4 ft LPS-7-01
K2.0006758	Cable LBUS to D-Tap 0,8 m/2.6 ft LPS-7
K2.0006759	Cable LBUS to RS 0,8 m/2.6 ft LPS-1
K2.0006760	Cable LBUS to XLR-4 0,8 m/2.6 ft LPS-6
K2.0012630	Cable LBUS (2x angled), 0,8 m/2.6 ft
K2.0013042	Cable LBUS (angled, straight), 0,35 m/1.15 ft
K2.0013041	Cable LBUS (angled, straight), 1 m/3.3 ft
K2.0013040	Cable LBUS (2x angled), 0,6 m/2 ft
K2.0013043	Cable LBUS (angled, straight), 0,8 m/2.6 ft
K2.0013044	Cable LBUS (angled) to LCS 0,8 m/2.6 ft
K2.0012785	Cable LBUS (2x angled), 0,2 m/8"
K2.0009643	Cable AMIRA/ALEXA MINI EXT to LBUS (straight) 0,8 m/2.6 ft
K2.0012628	Cable AMIRA/ALEXA MINI EXT to LBUS (angled) 0,8 m/2.6 ft

⚠ DANGER!**Risk of fire!**

Short-circuits and back currents to power supplies/batteries may entail lethal damage!

Always use original ARRI/cmotion LBUS cables to external power sources (D-Tap, XLR)! ARRI/cmotion LBUS cables to external power sources provide a protection circuit to prevent back currents to power supplies/batteries.

Mechanical accessories

K2.0012913	Handgrip Extension 80mm	
K2.0012911	Handgrip Extension 160mm	
K2.0012917	Handgrip Extension 240mm	
K2.0012921	Cable clip 15mm	
K2.0012918	Pan Bar Adapter 18mm	
K2.0012919	Pan Bar Adapter 20mm	
K2.0012920	Clamp adapter	
K2.0013007	Rod Mounting Bracket RMB-4	
K2.66255.0	15 mm Reduction Insert	
K2.47136.0	Extension Tube for Handgrip	

K2.0012965 Master Grip Case



Master Grip mechanical accessory sets

KK.0013223 (equals K0.0012991)	Handgrip extension 80 mm with cable clip
K2.0012913	Handgrip Extension 80 mm
K2.0012921	Cable Clip 15 mm

KK.0013224 (equals K0.0012992)	Handgrip extension 160 mm with cable clip
contains	
K2.0012911	Handgrip Extension 160 mm
K2.0012921	Cable Clip 15 mm

KK.0013220 (contains K0.0012993)	Handgrip extension 240 mm with cable clip
contains	
K2.0012917	Handgrip Extension 240 mm
K2.0012921	Cable Clip 15 mm

KK.0013225 (equals K0.0013013)	Rod Mounting Bracket Set
contains	
K2.0013007	Rod Mounting Bracket RMB-4
K2.66255.0	15 mm Reduction Insert

13.2 Pinouts

LBUS Connector

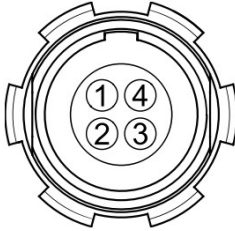

- 1 GND Ground
- 2 CAN-L CAN bus
- 3 V-BAT Power supply in-/output
- 4 CAN-H CAN bus

13.3 Compatibility

Cameras and lenses

	ALEXA LF	ALEXA Plus	AMIRA	ALEXA Mini	RED EPIC/ WEAPON	SONY F5/ F55	ENG Camera
REC start/ stop and tally	SUP 4.0 A	SUP 11 A	SUP 4 C	SUP 4 B/C	via CUB-1 SUP 2	via CUB-1 SUP 2	
User Buttons	SUP 4.0 A	SUP 11 A	SUP 4: WCU-4 User Buttons		YES		
			SUP 5: Master Grip User Buttons				
OVR (Override)	SUP 4.0 A	via UMC-4 SUP 2.1 via cforce mini RF SUP 1.2	via UMC-4 SUP 2.1 via cforce mini RF SUP 1.2	SUP 5.4 B/C	via UMC-4 SUP 2.1 via cforce mini RF SUP 1.2	via UMC-4 SUP 2.1 via cforce mini RF SUP 1.2	
F/I/Z cforce Motors	YES	YES	YES	YES	YES	YES	YES
F/I/Z CLM Motors	YES	YES A					

	ALEXA LF	ALEXA Plus	AMIRA	ALEXA Mini	RED EPIC/ WEAPON	SONY F5/ F55	ENG Camera
F//Z ENG Lenses		via CUB-2	SUP 5 C	SUP 5 C	via CUB-2	via CUB-2	via CUB-2
Iris EF Lenses			SUP 5 C	SUP 5 C			
Lens Data Display on Master Grip	YES A	YES A	YES	SUP 4 B/C	via CUB-2	via CUB-2	via CUB-2

- **A:** LCS Interface
- **B:** LBUS Interface
- **C:** EXT Interface

Motor controllers and lenses

	cforce mini RF	UMC-4	SMC-1	EMC-1	AMC-1	Servo-Zoom
REC start/stop and tally *	SUP 1.0	SUP 1.42	SUP 1.29	SUP 1.3	SUP 1.44	via CUB-2
ALEXA User Buttons *	SUP 1.1	with ALEXA EV				
WCU-4 User Buttons *		SUP 1.42				
Master Grip User Buttons *		SUP 1.42				
F//Z cforce Motors	SUP 1.0	SUP 1.42			SUP 1.44	
F//Z CLM Motors	SUP 1.0	SUP 1.42	SUP 1.29			
F//Z ENG Lenses	SUP 1.0			SUP 1.3		via CUB-2
Lens Data Display on Master Grip	SUP 1.0	SUP 1.42				via CUB-2

	cforce mini RF	UMC-4	SMC-1	EMC-1	AMC-1	Servo- Zoom
OVR (Override)	SUP 1.1	SUP 2.1				

* With connected camera

Stabilized Remote Head SRH-3

Master Grips are compatible with ARRI's Stabilized Remote Head SRH-3 Control Panel. They can control cforce lens motors connected to the SRH-3 head or can control the roll axis of the SRH-3 head.

13.3.1 Software update devices

Device	Software update package
ALEXA	not supported
AMIRA	not supported
ALEXA MINI	SUP 5.4
UMC-4	SUP 2.1
SMC-1	not supported
EMC-1	not supported
AMC-1	SUP 2.0
WCU-4	SUP 3.2

NOTICE

For questions about hardware not listed above please contact service@arri.com.

13.4 Specifications

Temperature range:	-20 to +50° C (-4 to +122° F)
Supply voltage:	12 - 34 V
Current consumption Wheel:	30mA @ 24V
Current consumption Rocker:	15mA @ 24V

13.4.1 Dimensions and weight

Dimensions:

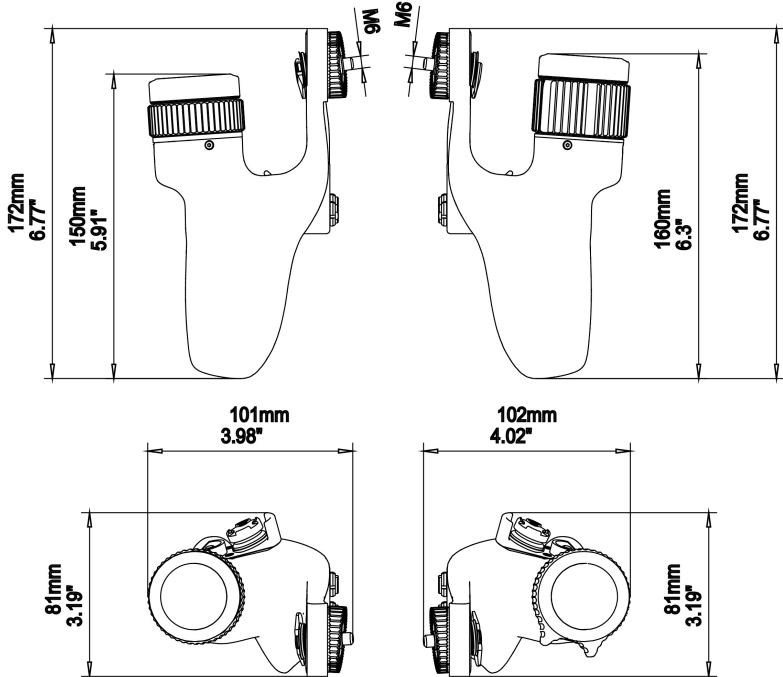

Weight:

MRW-1/WLW-1:	380g / 13.4oz
MRR-1/MLR-1:	420g / 14.8oz

13.5 Service Contacts

Munich, Germany

ARRI Cine + Video Technik

+49 89 3809 2121

service@arri.de

Business hours:

Mo. - Fr. 9:00 - 17:00 (CET)

London, Great Britain

ARRI CT Limited

+44 1895 457 051

service@arri-ct.com

Business hours:

Mo. - Thu. 9:00 - 17:30

Fr. 9:00 - 17:00 (GMT)

Burbank, USA

ARRI Inc. West Coast

+1 877 565 2774

service@arri.com

Business hours:

Mo. - Fr. 8:15 - 17:00 (PST)

Mississauga, Canada

ARRI Canada Limited

+1 416 255 3335

service@arri.com

Business hours:

Mo. - Fr. 8:30 - 17:00 (EDT)

Beijing, China

ARRI China Co. Limited

+86 10 5900 9680

service@arrichina.com

Business hours:

Mo. - Fr. 9:00 - 18:00 (CST)

Vienna, Austria

ARRI Cine + Video Geräte

Ges.m.b.H.

+43 1 8920107 30

service@arri.at

Business hours:

Mo. - Fr. 9:00 - 17:00 (CET)

Milan, Italy

ARRI Italia S.r.l.

+39 (02) 262 271 75

info@arri.it

Business hours:

Mo. - Fr. 9:00 - 18:00 (CET)

New York, USA

ARRI Inc. East Coast

+1 877 565 2774

service@arri.com

Business hours:

Mo. - Fr. 8:00 - 17:30 (EST)

Hong Kong, China

ARRI Asia Limited

+852 2537 4266

service@arriasia.hk

Business hours:

Mo. - Fr. 10:00 - 18:30 (HKT)

Sydney, Australia

ARRI Australia Pty Ltd

+61 2 9855 4305

service@arri.com.au

Business hours:

Mo. - Fr. 8:00 - 18:00 (AEST)

13.6 International declarations

EC Declaration of Conformity

The product conforms with the specifications of the following European directives:

- Directive 2014/30/EU of the European Parliament and the Council of 26 February 2014 on the harmonization of the laws of the Member States relating to electromagnetic compatibility
- Directive 2011/65/EU of the European Parliament and the Council of 8 June 2011 on the restriction of the use of certain hazardous substances in electrical and electronic equipment

The compliance with the requirements of the European Directives was proved by the application of the following harmonized standards:

- EN 55103-1:2009; EN 55103-2:2009



FCC Class A Statement

Note: This equipment has been tested and found to comply with the limits for a Class A digital device, pursuant to Part 15 of the FCC Rules. These limits are designed to provide reasonable protection against harmful interference when the equipment is operated in a commercial environment. This equipment generates, uses, and can radiate radio frequency energy and, if not installed and used in accordance with the instruction manual, may cause harmful interference to radio communications. Operation of this equipment in a residential area is likely to cause harmful interference in which case the user will be required to correct the interference at his own expense.

Industry Canada Compliance Statement

Complies with the Canadian ICES-003 Class A specifications. Cet appareil numérique de la Classe A est conforme à la norme NMB-003 du Canada. This device complies with RSS 210 of Industry Canada. Cet appareil est conforme à CNR-210 d'Industrie Canada. This Class A device meets all the requirements of the Canadian interference-causing equipment regulations. Cet appareil numérique de la Classe A respecte toutes les exigences du Règlement sur le matériel brouilleur du Canada.